

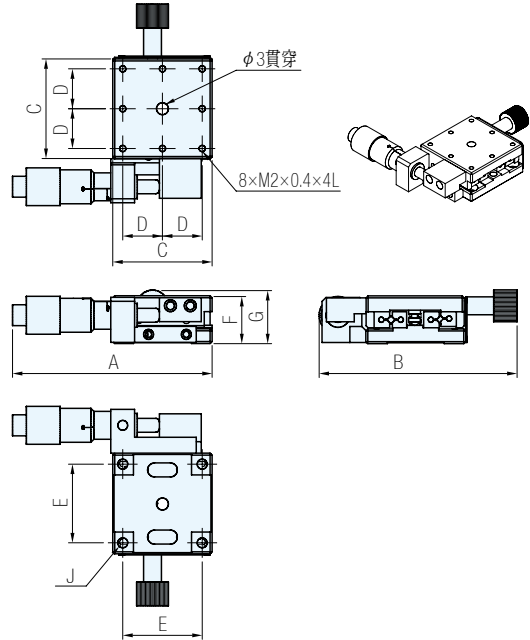

L(左側), 檯面25

R(右側), 檯面25

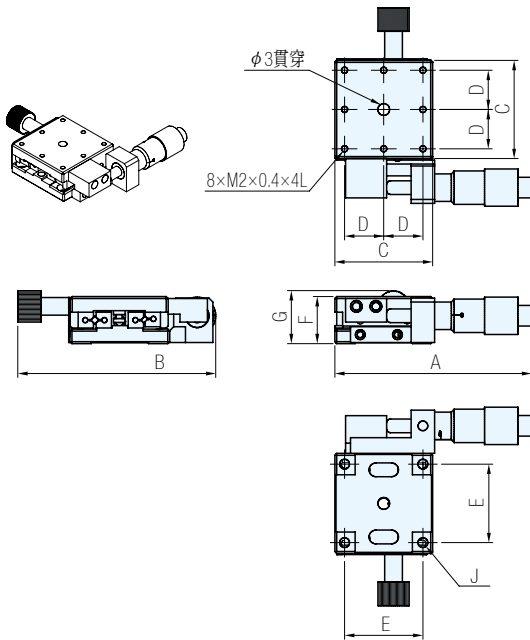

L(左側), 檯面40

R(右側), 檯面40

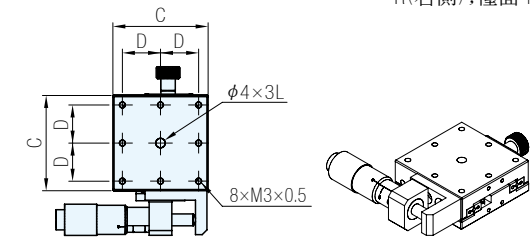
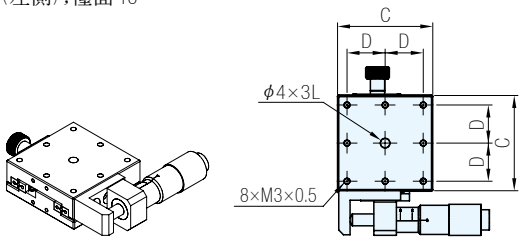

L(左側), 檯面50

R(右側), 檯面50

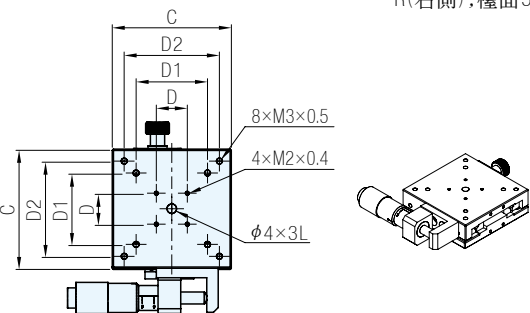
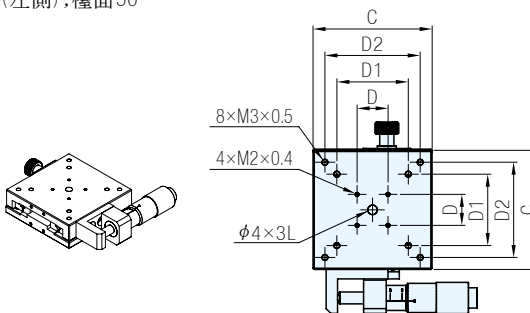

L(左側), 檯面60

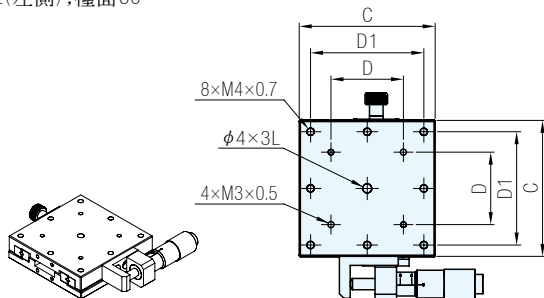

R(右側), 檯面60

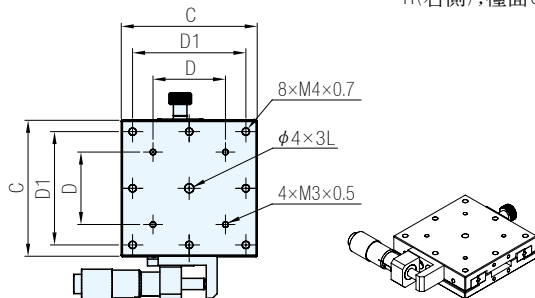

L(左側), 檯面80

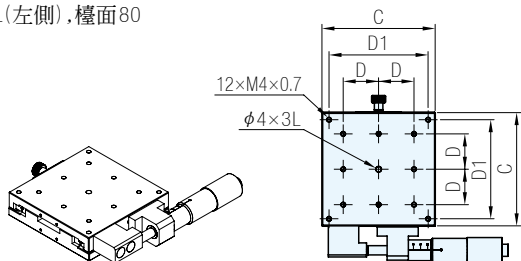

R(右側), 檯面80

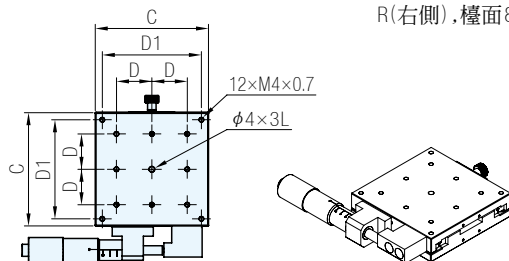

L(左側), 檯面100

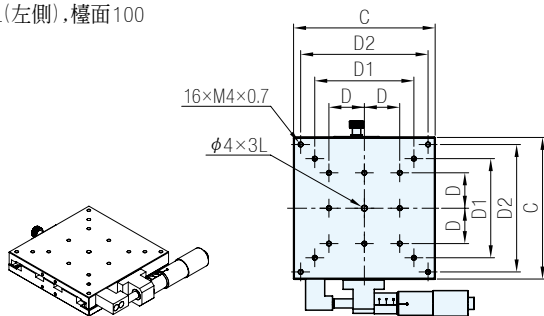

R(右側), 檯面100

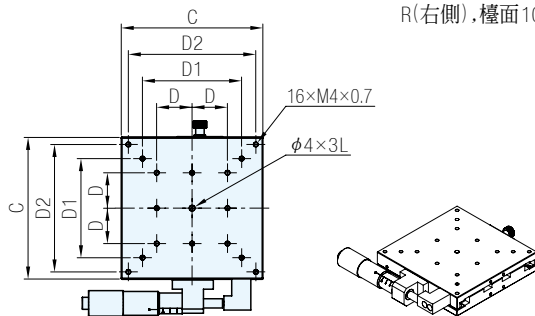

品 號	檯面 C	A	B	D	D1	D2	E	F	G	J	備註	軸位
AFX-0040	25	(50.25)	( 50.6)	10	-	-	20	12	(13.5)	表面4×φ2.5貫穿(下板), 底φ4.2深2.5沉孔	VR1型, 旁式X軸	L(左側)
AFX-0041												R(右側)
AFX-0030	40	( 63.8)	( 70.8)	16	-	-	32	16	(15.8)	表面4×φ3.5貫穿(下板), 底φ6深3.2沉孔		L(左側)
AFX-0031												R(右側)
AFX-0032	50	( 68.8)	( 80.4)	13	30	40	40	16	(16.2)			L(左側)
AFX-0033												R(右側)
AFX-0034	60	( 81 )	( 90.8)	32	50	-	50	16	(16.2)	表面4×φ4.5貫穿(下板), 底φ8.5皿孔	VR2型, 旁式X軸	L(左側)
AFX-0035												R(右側)
AFX-0036	80	(131.5)	(118.3)	25	70	-	70	20	(20 )			L(左側)
AFX-0037												R(右側)
AFX-0038	100	(127.5)	(137.8)	25	70	90	90	20	(20.3)	表面4×φ4.5貫穿(下板), 底φ8深4.5沉孔		L(左側)
AFX-0039												R(右側)

Ps. 備註

· 材質、規格表等詳細資料請參閱AFX・AFY首頁

訂貨： 品 號 交期： 14 天

AFX-0040